

ASSEMBLY INSTRUCTIONS

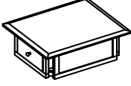
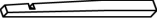
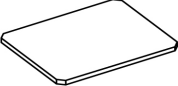

SM2024

PARTS CHECK LIST

Item	Part name	Qty.
A		1
B		4
C		1

Thank you for purchasing this product. It has been designed for assembly so please follow the assembly instruction below

HARDWARE

Item	Description		Qty.
	Photo	Specification	
C		Bolts 5/16"x60mm Lock washer 5/16" Flat washer 5/16"	8
D		Screw 4x40mm	4
E		4x60mm	1

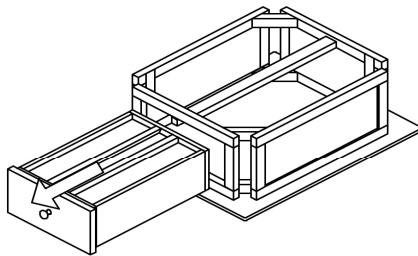

STEP 1

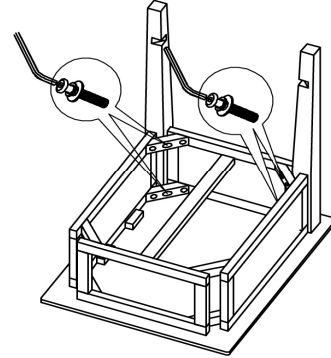

STEP 2

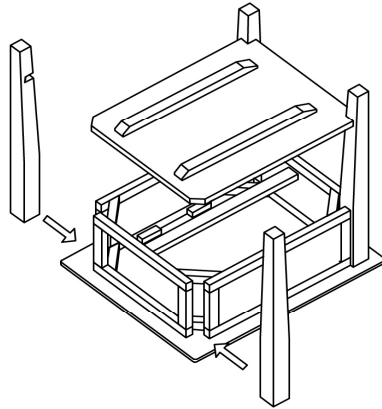

STEP 3

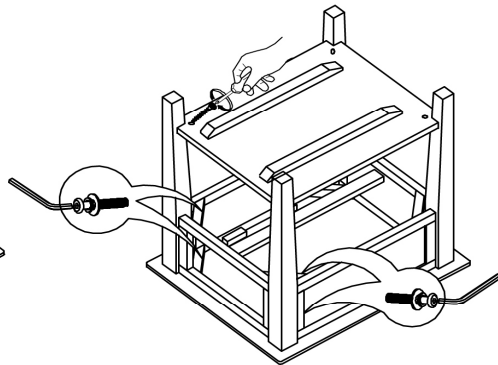

STEP 4

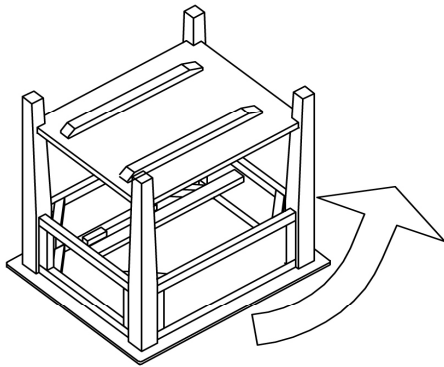

STEP 5

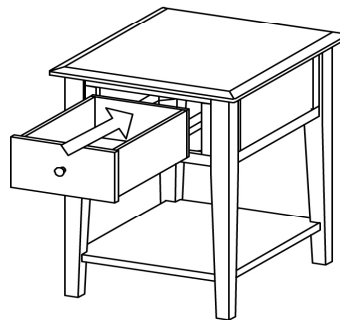

STEP 6

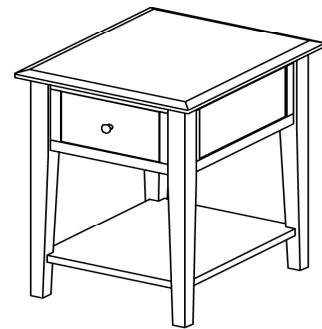

FINISH